

DIFFUSEURS

Konika-A - Konika - DCFP



- Diamètre 125 à 500
- RAL 9010
- Konika 600 et DCFP :
version pour dalles de faux-plafond

DIMENSIONS

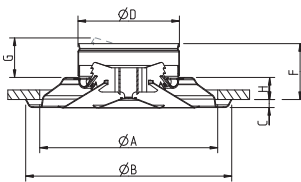

Konika-A	øA	øB	C	øD	E	F
Konika-A160	279	323	12	160	22	85
Konika-A200	375	428	10	200	26	101
Konika-A250	467	538	14	250	33	117
Konika-A315	557	635	10	315	42	135
Konika-A400	740	856	14	400	49	166
Konika-A500	924	1081	17	500	72	199

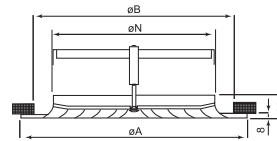

Konika	øA	øB	øN
Konika-160	248	190	158
Konika-200	298	230	198
Konika-250	363	280	248
Konika-315	448	350	313

Les cotes hors tout des DCFP et Konika 600 sont de 595 x 595

COURBES Konika-A / DCFP

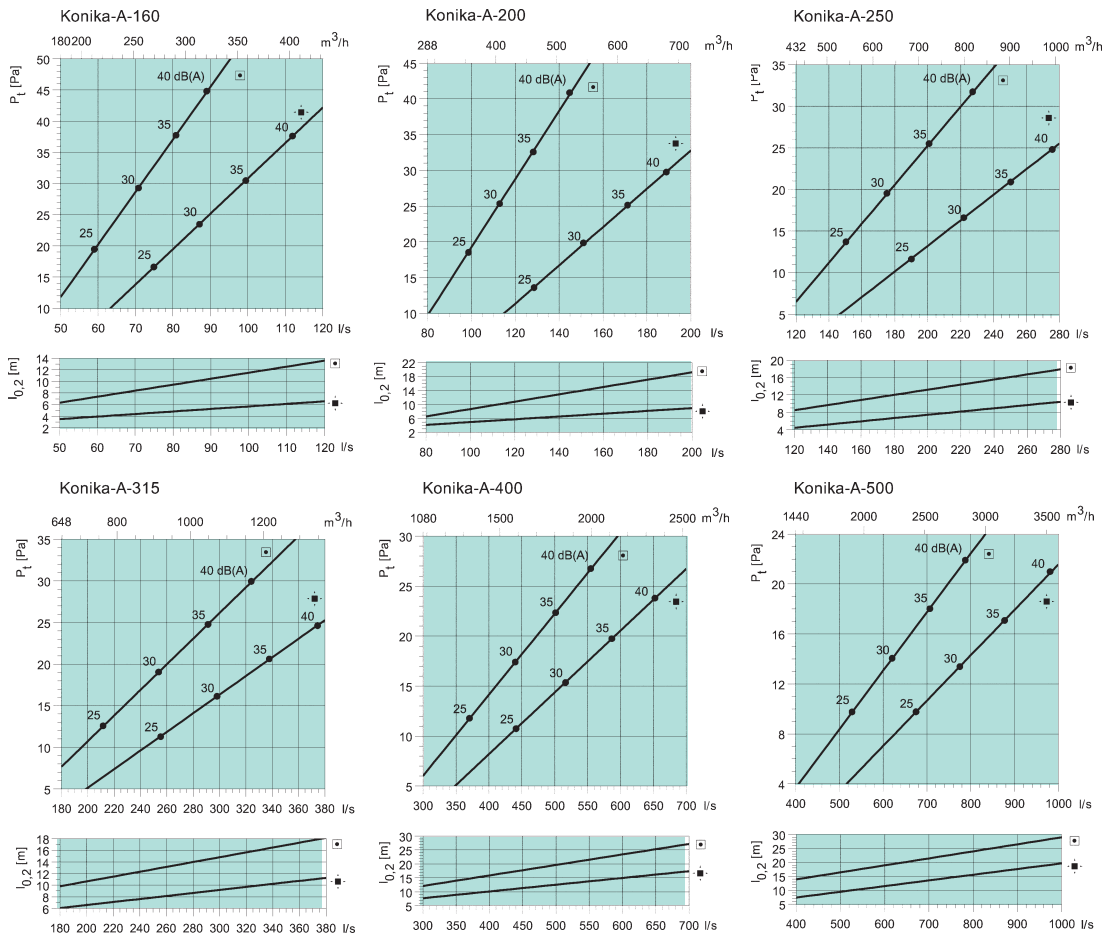

CARACTÉRISTIQUES Konika / Konika 600

Konika	25 dB(A)		30 dB(A)		35 dB(A)		40 dB(A)	
	m³/h	PdC[Pa]	m³/h	PdC[Pa]	m³/h	PdC[Pa]	m³/h	PdC[Pa]
Konika160	195	15	235	24	280	28	342	39
Konika200	238	12	285	16	342	21	407	26
Konika250	324	10	385	14	468	18	558	24
Konika315	468	11	558	15	670	20	810	27

Référence Prix Euros

Référence	Prix Euros
Diffuseurs Konika-A	
Konika-A-160	71,20
Konika-A-200	87,20
Konika-A-250	119,10
Konika-A-315	138,30
Konika-A-400	157,20
Konika-A-500	235,00

Adaptation faux-plafond 600x600 pour Konika-A	
TPP-600-125	63,00
TPP-600-160	63,00
TPP-600-200	63,00

Diffuseurs Konika	
Konika-160	20,90
Konika-200	27,60
Konika-250	33,40
Konika-315	41,50

Diffuseurs pour dalles de faux-plafond 600x600	
Konika 600-160	77,70
Konika 600-200	83,10
Konika 600-250	89,80
Konika 600-315	99,00

Diffuseurs DCFP	
Diffuseurs pour dalles de faux-plafond 600x600	
DCFV 100-600	106,10
DCFV 160-600	106,10
DCFV 200-600	117,50
DCFV 250-600	143,50
DCFV 315-600	188,00

Resgistres pour DCFP	
REC 100	30,70
REC 160	32,90
REC 200	35,30
REC 250	42,30
REC 315	54,10

Plenums insonorisés pour Konika, Konika-A, DCFP	
PER 100-125	79,70
PER 125-160	83,90
PER 160-200	88,20
PER 200-250	104,90
PER 250-315	155,20
PER 315-400	159,40

● En stock

GRILLES MURALES DOUBLE DEFLEXION

GSV



GSV



- Fabrication en acier laqué blanc
- Conception robuste
- Existent en 9 tailles
- Ailettes mobiles
- Raccordement possible avec plénum PRG

DIMENSIONS

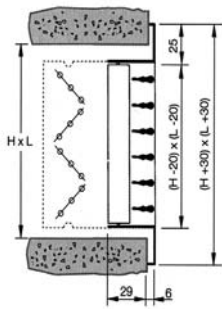

Avec le registre GSS, la profondeur augmente de 29 à 80 mm.

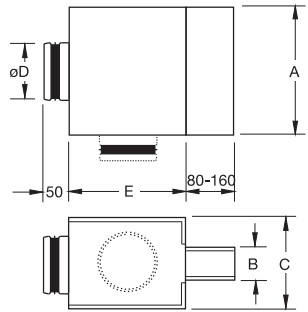

TAILLE	GRILLE GSV		PLENUM PRG				
	L	H	A	B	C	D	E
200x100	200	100	200	100	175	124	190
300x100	300	100	300	100	210	159	220
400x100	400	100	400	100	250	199	270
500x100	500	100	500	100	300	249	320
300x150	300	150	300	150	250	199	270
400x150	400	150	400	150	300	249	320
500x150	500	150	500	150	350	299	370
500x200	500	200	500	200	370	314	380
600x200	600	200	600	200	370	314	380

PERFORMANCES

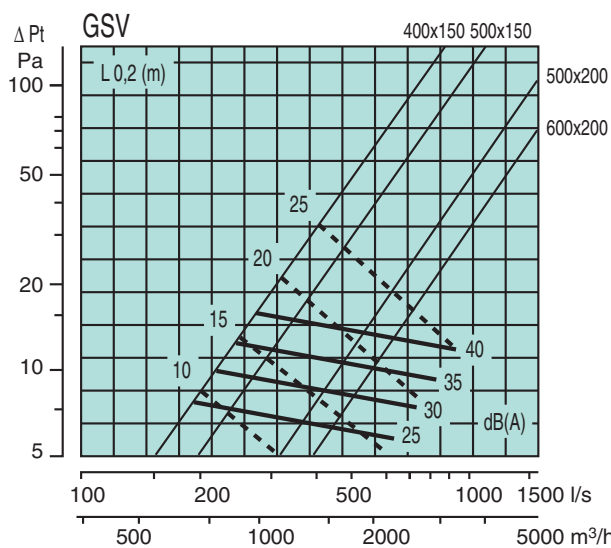
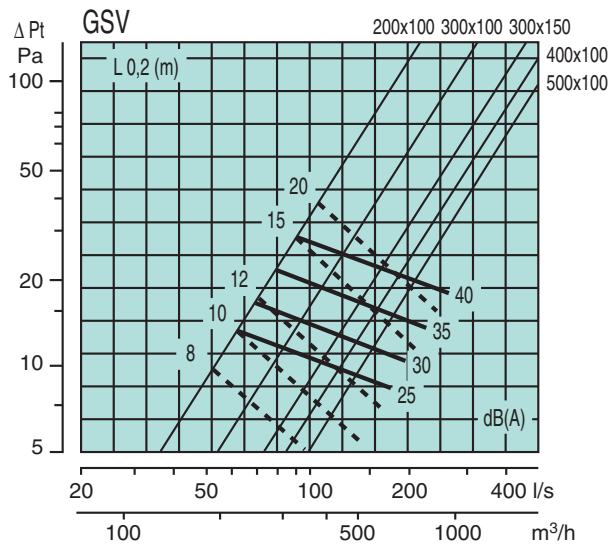

Référence Prix Euros

Grilles à double déflexion

GSV-200x100	16,10
GSV-300x100	18,30
GSV-300x150 X	21,40
GSV-400x100	20,80
GSV-400x150	23,90
GSV-500x100	23,00
GSV-500x150	28,00
GSV-500x200	33,10
GSV-600x200	37,90

Plénums connexion arrière

PRG-1-200-100	117,50
PRG-1-300-100	134,20
PRG-1-300-150	155,20
PRG-1-400-100	159,40
PRG-1-400-150	176,20
PRG-1-500-100	188,70
PRG-1-500-150	193,00
PRG-1-500-200	193,00
PRG-1-600-200	218,20

Plénums connexion latérale

PRG-2-200-100	117,50
PRG-2-300-100	134,20
PRG-2-300-150	155,20
PRG-2-400-100	159,40
PRG-2-400-150	176,20
PRG-2-500-100	188,70
PRG-2-500-150	193,00
PRG-2-500-200	193,00
PRG-2-600-200	218,20

Registres de réglage

GSS-200x100	13,30
GSS-300x100	14,40
GSS-300x150	17,00
GSS-400x100	16,70
GSS-400x150	18,50
GSS-500x100	21,70
GSS-500x150	21,10
GSS-500x200	28,70
GSS-600x200	32,30

● En stock

GRILLES MURALES FIXES

GAG



GAG

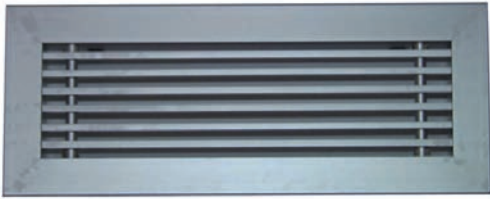

- Fabrication en aluminium
- Conception robuste
- Existents en 9 tailles
- Ailettes fixes
- Raccordement possible avec plénum PRG

DIMENSIONS

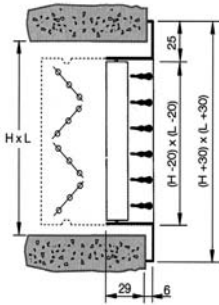

Avec le registre GSS, la profondeur augmente de 29 à 80 mm.

TAILLE	GRILLE GAG		PLENUM PRG				
	L	H	A	B	C	D	E
200x100	200	100	200	100	175	124	190
300x100	300	100	300	100	210	159	220
400x100	400	100	400	100	210	159	220
500x100	500	100	500	100	250	199	270
300x150	300	150	300	150	250	199	270
400x150	400	150	400	150	300	249	320
500x150	500	150	500	150	300	249	320
500x200	500	200	500	200	370	314	380
600x200	600	200	600	200	370	314	380

PERFORMANCES

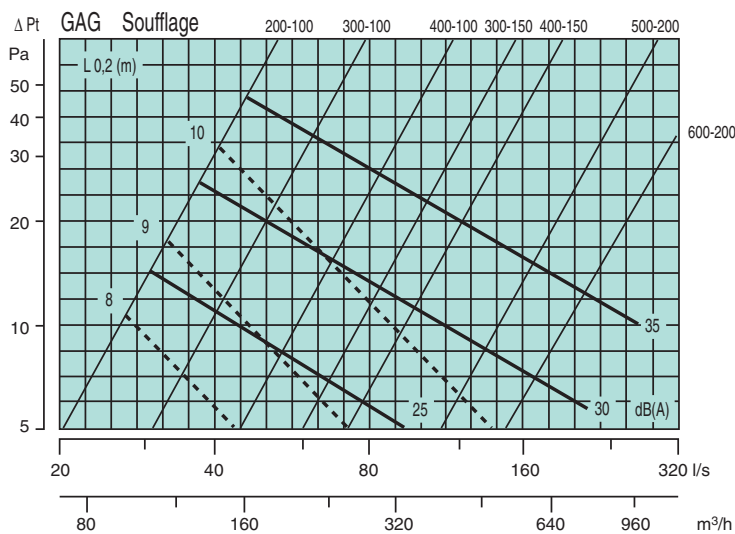
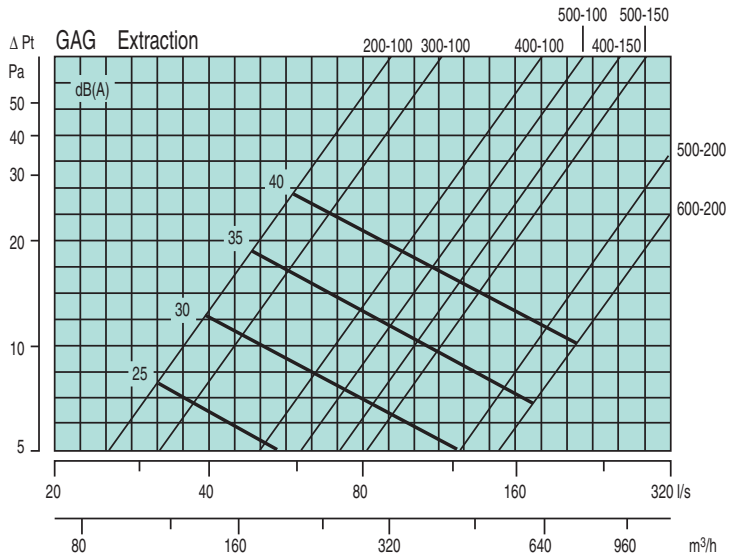

Référence Prix Euros

Grilles à ailettes fixes

GAG-200x100	27,90
GAG-300x100	32,30
GAG-300x150	44,00
GAG-400x100	38,10
GAG-400x150	49,90
GAG-500x100	44,00
GAG-500x150	58,70
GAG-500x200	70,40
GAG-600x200	79,20

Plénums connexion arrière

PRG-I-200-100	117,50
PRG-I-300-100	134,20
PRG-I-300-150	155,20
PRG-I-400-100	159,40
PRG-I-400-150	176,20
PRG-I-500-100	188,70
PRG-I-500-150	193,00
PRG-I-500-200	193,00
PRG-I-600-200	218,20

Plénums connexion latérale

PRG-2-200-100	117,50
PRG-2-300-100	134,20
PRG-2-300-150	155,20
PRG-2-400-100	159,40
PRG-2-400-150	176,20
PRG-2-500-100	188,70
PRG-2-500-150	193,00
PRG-2-500-200	193,00
PRG-2-600-200	218,20

Registres de réglage

GSS-200x100	13,30
GSS-300x100	14,40
GSS-300x150	17,00
GSS-400x100	16,70
GSS-400x150	18,50
GSS-500x100	21,70
GSS-500x150	21,10
GSS-500x200	28,70
GSS-600x200	32,30

GRILLES



GDC



- Grille de décompression avec contre-cadre
- Bon aspect esthétique (aluminium anodisé)
- Facile d'installation
- Faible perte de charge

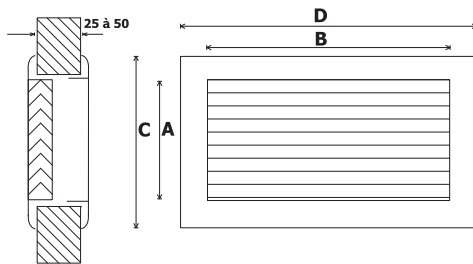

TYPE	3m/s			4m/s			5m/s		
	Débit (m³/h)	PDC (Pa)	DBA (1.5m)	Débit (m³/h)	PDC (Pa)	DBA (1.5m)	Débit (m³/h)	PDC (Pa)	DBA (1.5m)
GDC1	150	7	22	300	26	37	450	60	46
GDC2	210	6	24	420	25	39	630	56	48
GDC3	300	5	25	600	20	40	900	50	49
GDC4	380	...	26	760	18	41	1140	45	50
GDC5	600	...	28	1200	14	43	1800	35	52

TYPE	A	B	C	D	Ouverture à ménager
GDC1	176	276	226	326	300x200
GDC2	176	376	226	426	400x200
GDC3	276	376	326	426	400x300
GDC4	276	476	326	526	500x300
GDC5	375	576	426	626	600x400

Référence Prix Euros

Grilles de reprises murs et portes

GDC1	96,90
GDC2	134,70
GDC3	154,30
GDC4	212,50
GDC5	269,30

GRF



- Grille de reprise avec filtre (G3)
- Taille 57x57 conçue pour montage en dalle 600x600

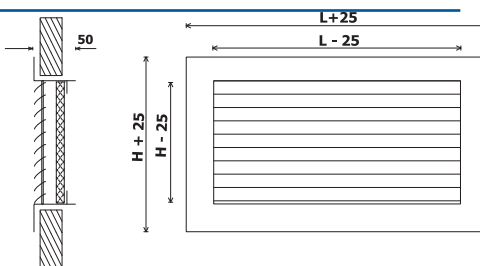

TYPE (HxL)	Débit maxi m³/h	Perte de charge Pa
GRF 57x27	1045	70
GRF 57x57	2300	70

Grilles de reprises avec filtre type GRF

GRF33X54	282,80
GRF54X54	403,20

GDD

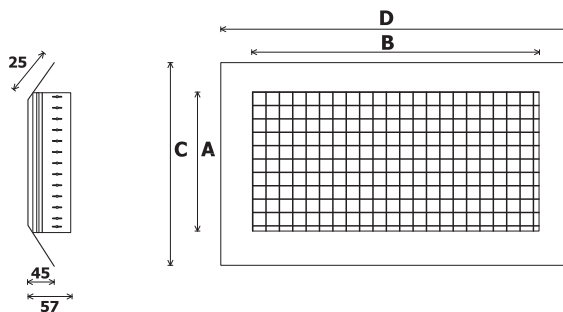
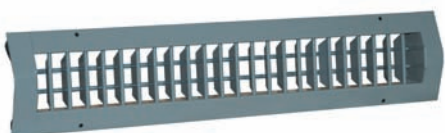

TYPE	3m/s			4m/s			5m/s		
	Débit (m³/h)	PDC (Pa)	DBA (1.5m)	Débit (m³/h)	PDC (Pa)	DBA (1.5m)	Débit (m³/h)	PDC (Pa)	DBA (1.5m)
GDD1	235	4	10	310	5	16	390	8	22
GDD2	270	...	11	360	6	17	450	11	23
GDD3	360	...	12	480	5	18	600	9	25

TYPE	A	B	C	D	Ouverture à ménager
GDD1	57	400	107	450	415x72
GDD2	57	480	107	530	495x72
GDD3	57	560	107	610	575x72

Grilles pour gaines circulaires type GDD

GDD1	76,60
GDD2	87,00
GDD3	92,40

Registres à glissières pour GDD

DAMP.GDD1	57,40
DAMP.GDD2	68,50
DAMP.GDD3	70,70

GEL



- Grille étanche à la lumière (couleur noire)
- Montage intérieur et extérieur
- Grilles composées de chevrons noirs
- Pour obtenir une bonne opacité, utiliser 2 grilles dos à dos.

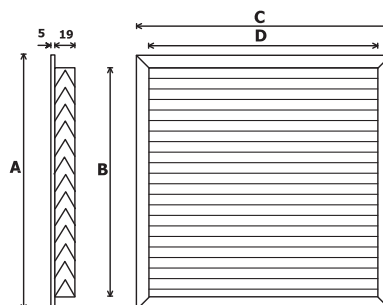

GEL	A	B	C	D
1	344	298	344	298
2	494	438	494	438
Surface libre GEL1 350 cm² GEL2 955 cm²				

Grilles étanches à la lumière type GEL

GEL1	193,30
GEL2	297,70

GRILLES



EG

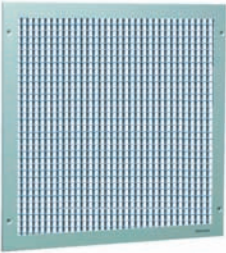

- Grille à résille en aluminium
- Très faible perte de charge

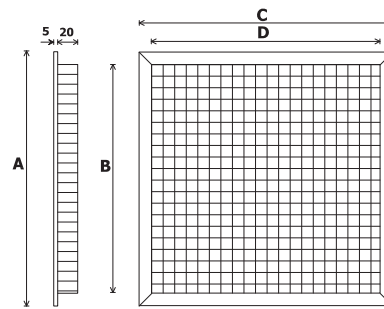

Référence	Prix Euros
Grilles à résille type EG	
EG1	99,50
EG2	121,00

EG	A	B	C	D
1	340	285	340	285
2	490	440	490	440

EXTA



- Fabrication en aluminium anodisé
- Ailettes inclinées à 45°
- Equipées de grillage anti-volatile
- Fixation en applique (cadre non percé) ou par contre-cadre à sceller (en accessoire)

SECTION GRILLES EXTERIEURES EXTA Ak

Ak en m²	LARGEUR							
HAUTEUR	300	400	500	600	700	800	900	1000
390	0,046	0,069	0,092	0,114	0,137	0,160	0,183	0,206
490	0,058	0,087	0,116	0,145	0,174	0,203	0,232	0,261
590	0,070	0,105	0,140	0,175	0,210	0,246	0,281	0,316
690	0,082	0,124	0,165	0,206	0,247	0,288	0,329	0,371
790	0,095	0,142	0,189	0,236	0,284	0,331	0,378	0,425
890	0,107	0,160	0,214	0,267	0,320	0,374	0,427	0,480
990	0,119	0,178	0,238	0,297	0,357	0,416	0,476	0,535

PRIX

GRILLES EXTERIEURES EXTA								
Réf : EXTA	HAUTEUR							
LARGEUR	290	390	490	590	690	790	890	990
400	120,00	142,20	152,60	164,90	174,90	184,90	197,60	207,50
500	125,10	149,90	164,90	182,50	197,60	214,90	225,60	247,50
600	150,40	155,00	177,50	199,90	219,90	242,50	264,90	284,90
700	139,90	164,90	189,90	217,50	244,90	269,90	297,50	324,90
800	147,60	169,90	202,50	234,90	267,50	299,90	325,10	362,50
900	155,00	177,50	214,90	289,90	327,50	327,50	364,90	402,50
1000	162,60	184,90	227,60	270,40	312,50	354,90	397,50	439,90

DIMENSIONS

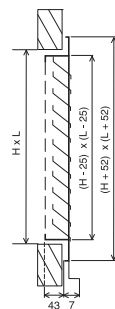

PERTES DE CHARGE

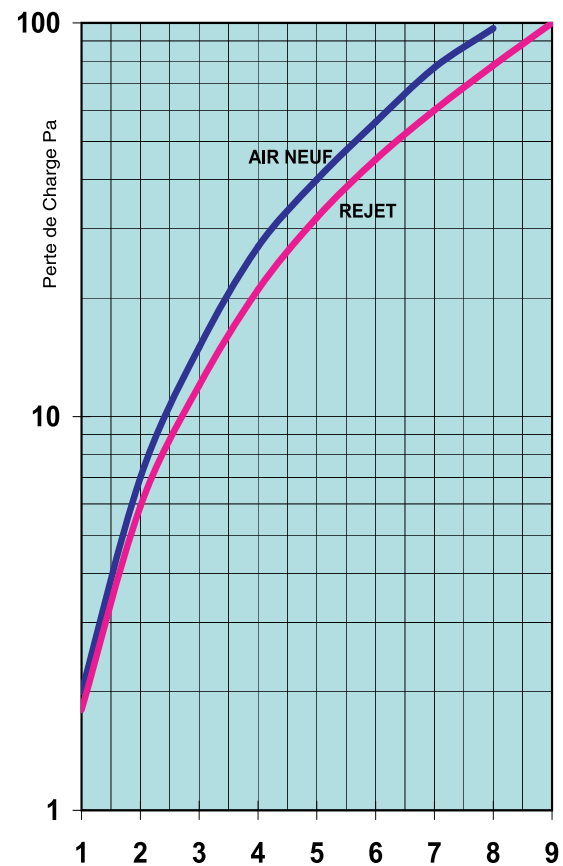

CONTRES CADRES EXTA								
Réf : CC	HAUTEUR							
LARGEUR	290	390	490	590	690	790	890	990
400	49,72	52,80	58,08	60,06	64,24	68,31	72,49	76,67
500	54,89	60,06	61,16	66,33	69,41	72,49	75,57	81,73
600	54,89	60,06	63,14	67,32	72,49	75,57	81,73	85,91
700	61,16	63,14	69,41	72,49	77,66	81,73	87,01	91,08
800	66,33	67,32	72,49	75,57	79,75	84,92	90,09	95,26
900	69,41	72,49	77,66	81,73	87,01	90,09	96,36	99,44
1000	72,49	75,57	81,73	84,92	91,08	96,36	99,44	103,51

GRILLES



IGC



- Aluminium moulé
- Grillage anti-rongeur

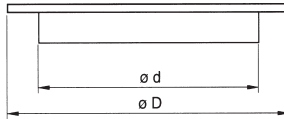

IGC Diam.	d	D	Poids Kg
100	100	140	0,15
125	125	160	0,2
160	160	195	0,4
200	200	235	0,8
250	250	280	1,1
315	315	355	1,6

SG

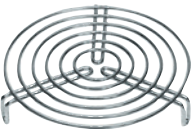

- Pour montage en bout de conduit sur ventilateur
Du diamètre 100 au diamètre 500.
Fabrication en fil d'acier
En respect de la norme EN294, le pas entre les fils est de 8 mm maximum. La fixation s'effectue à l'aide de 3 vis sur les pattes courbées à 90°.

IGK



- A encastrer
- Grillage anti-rongeur

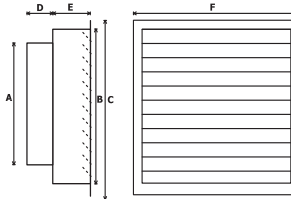

IGK Diam.	A	B	C	D	E	F
100	253	275	37	60	265	
125	253	275	37	60	265	
160	253	275	37	60	265	
200	253	275	41	60	265	
250	400	450	70	100	450	
315	400	450	70	100	450	

APPG-APPGR

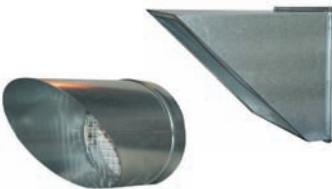

- Version circulaire (APPG) et rectangulaire (APPGR)
- Montage en bout de gaine ou sur ventilateur
- Versions APPGR aux cotes des ventilateurs KDR et MUB
- Equipés de grilles anti-rongeurs

APPG	L1	L2
100	+/- 1xD	+/- 2xD
125	+/- 1xD	+/- 2xD
160	+/- 1xD	+/- 2xD
200	+/- 0,5xD	+/- 1xD
250	+/- 0,5xD	+/- 1xD
315	+/- 0,5xD	+/- 1xD
355	+/- 0,5xD	+/- 1xD
400	+/- 0,5xD	+/- 1xD
450	+/- 0,5xD	+/- 1xD
500	+/- 0,5xD	+/- 1xD

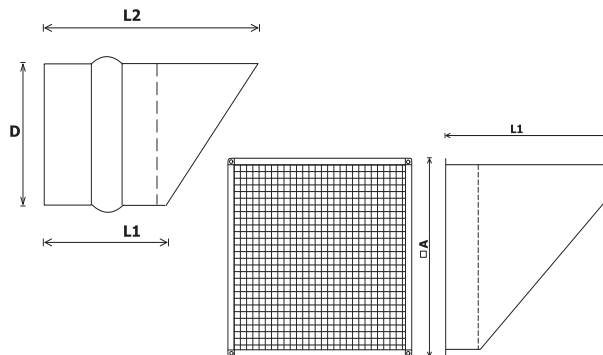

APPGR	A	L1
25	418	480
42	588	650
45	488	650
50	548	650
55	591	780
62	718	780
65	698	780
70	743	980
100	918	980

VAGE



- Matière plastique ABS blanc cassé
- Grille intérieure démontable
- Montage intérieur et extérieur

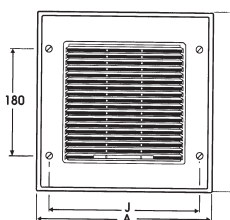

VAGE	A	B	J	Prof.
6	310	303	267	32
7	352	345	306	32
9	391	388	345	32
12	470	467	422	32

Référence Prix Euros

Grilles de prise d'air IGC

IGC 100	●	22,10
IGC 125	●	27,00
IGC 160	●	35,70
IGC 200	●	46,30
IGC 250	●	78,40
IGC 315	●	121,20

Grilles de protection

SG 100	●	6,60
SG 125	●	6,60
SG 160	●	8,90
SG 200	●	10,40
SG 250	●	15,90
SG 315	●	18,40
SG 355		28,70
SG 400		28,70
SG 450		45,20
SG 500		49,90

Grilles murales

IGK 100		58,40
IGK 125	●	69,40
IGK 160	●	74,60
IGK 200	●	77,60
IGK 250		180,40
IGK 315	●	180,40

Auvents grillagés circulaires

APPG0100		77,90
APPG0125	●	77,90
APPG0160	●	88,70
APPG0200	●	101,70
APPG0250	●	112,50
APPG0315	●	154,40
APPG0355	●	157,90
APPG0400	●	167,10
APPG0450	●	228,20
APPG0500	●	258,50

Auvents grillagés rectangulaires

APPGR100		580,40
APPGR25		417,20
APPGR42		458,00
APPGR45		468,00
APPGR50		474,80
APPGR55		488,30
APPGR62		502,00
APPGR65		508,80
APPGR70		542,70

Grilles d'extraction

VAGE6	●	36,70
VAGE7	●	36,50
VAGE9	●	54,60
VAGE12	●	46,40

● En stock

BOUCHES DE TRANSFERT INSONORISEES



OVR



- Capots et passage de mur insonorisés
- Longueur ajustable
- Installation simple
- Couleur blanc RAL 9010

Référence Prix
Euros

**Bouches de transfert
circulaire**
OVR-125 67,40
OVR-160 90,30

DIMENSIONS

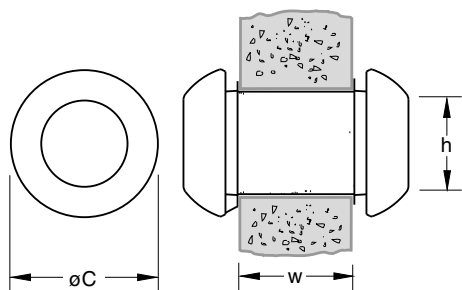

OVR	H	C	W
125	125	175	70-145
160	160	210	70-145

CARACTERISTIQUES

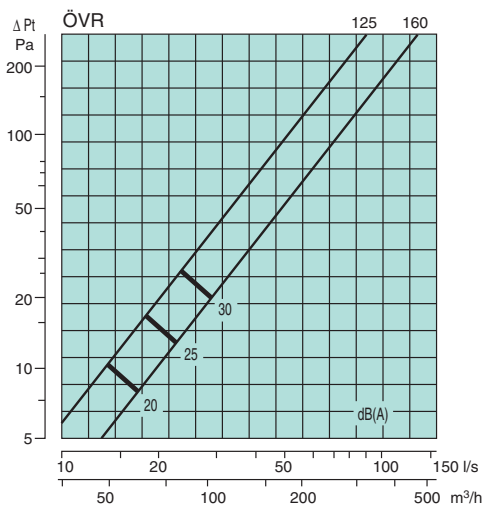

OVX



- Plaques frontales insonorisées
- Installation rapide
- Adaptable sur tous murs
- Couleur blanc RAL 9010

**Bouches de transfert
rectangulaire**
OVX-300 67,40
OVX-500 69,30
OVX-700 72,20
OVX-850 89,60

DIMENSIONS

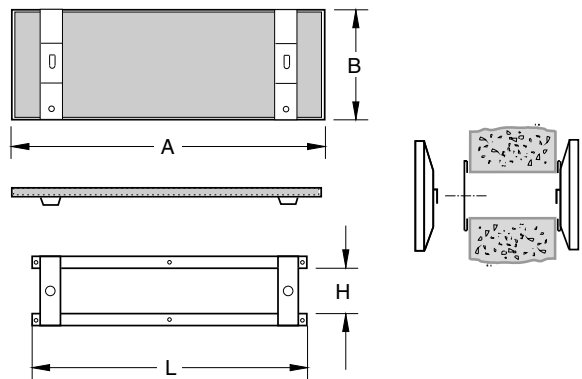

OVX	A	B	L	H
300	370	130	300	50
500	570	130	500	50
700	770	130	700	50
850	920	130	850	50

CARACTERISTIQUES

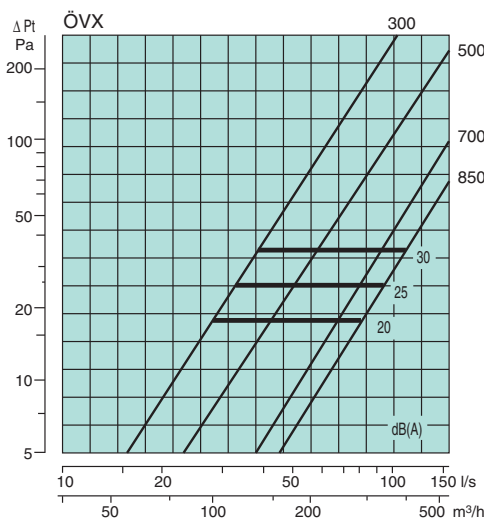

PLENUM

PER



PER



- Diamètre 125 à 400
- Entrée/Sortie circulaire
- Virole avec joint à lèvres
- Isolation thermique et acoustique
- Réglable par câble sans démontage de la grille
- Prises test pour mesure

DIMENSIONS

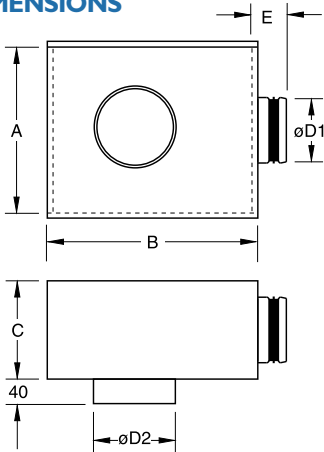

	A	B	C	øD	E	øD1	øD2
PER 100-125	250	320	150	45	185	99	126
PER 125-160	250	360	160	47	210	124	161
PER 160-200	300	450	195	47	280	159	202
PER 200-250	350	500	250	54	305	199	252
PER 250-315	450	565	300	54	330	249	317
PER 315-400	550	620	400	54	360	314	402

Afin de limiter les perturbations acoustiques et aérauliques, le diamètre de raccordement en gaine est inférieur d'une taille au diamètre du diffuseur.

Référence Prix Euros

Plénums insonorisés

PER 100-125		79,70
PER 125-160	●	83,90
PER 160-200	●	88,20
PER 200-250	●	104,90
PER 250-315	●	155,20
PER 315-400	●	159,40

PLENUM

PRG

PRG



- Diamètre 125 à 315 et 200x100 à 600x200
- Entrée circulaire/Sortie rectangulaire
- Virole avec joint à lèvres
- Isolation thermique et acoustique
- Réglable par câble sans démontage de la grille
- Prises test pour mesure

DIMENSIONS

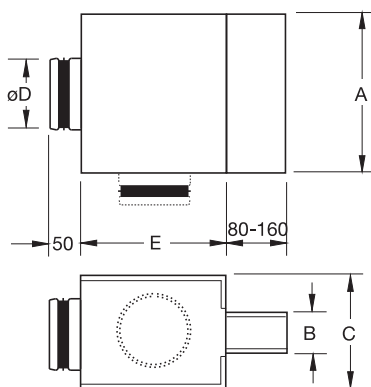

	A	B	C	øD	E	F	G
PRG 200X100	200	100	175	124	50	250	125
PRG 300X100	300	100	210	159	50	290	145
PRG 400X100	400	100	210	159	50	290	145
PRG 500X100	500	100	250	199	55	320	160
PRG 300X150	300	150	250	199	55	320	160
PRG 400X150	400	150	300	249	55	370	185
PRG 500X150	500	150	300	249	55	370	185
PRG 500X200	500	200	370	314	55	430	215
PRG 600X200	600	200	370	314	55	430	215

Plénums insonorisés

Plénums connexion arrière

PRG-1-200-100	117,50
PRG-1-300-100	134,20
PRG-1-300-150	155,20
PRG-1-400-100	159,40
PRG-1-400-150	176,20
PRG-1-500-100	188,70
PRG-1-500-150	193,00
PRG-1-500-200	193,00
PRG-1-600-200	218,20

Plénums connexion latérale

PRG-2-200-100	117,50
PRG-2-300-100	134,20
PRG-2-300-150	155,20
PRG-2-400-100	159,40
PRG-2-400-150	176,20
PRG-2-500-100	188,70
PRG-2-500-150	193,00
PRG-2-500-200	193,00
PRG-2-600-200	218,20

● En stock

REGISTRES A IRIS



SPI-SPM



- Contrôle précis des débits d'air
- Niveaux sonores réduits
- Entretien simple (ouverture complète possible)
- Equipé de 2 prises de pression pour mesure
- Etanchéité : classe C
- SPM : fermeture du registre à 100%

DIMENSIONS

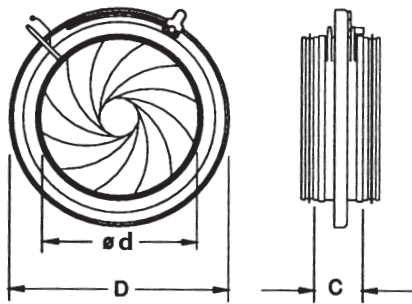

SPI	100	125	160	200	250	315	400
d	99	124	159	199	249	314	399
C	54	63	60	62	62	63	70
D	163	210	230	285	333	406	560

PERFORMANCES

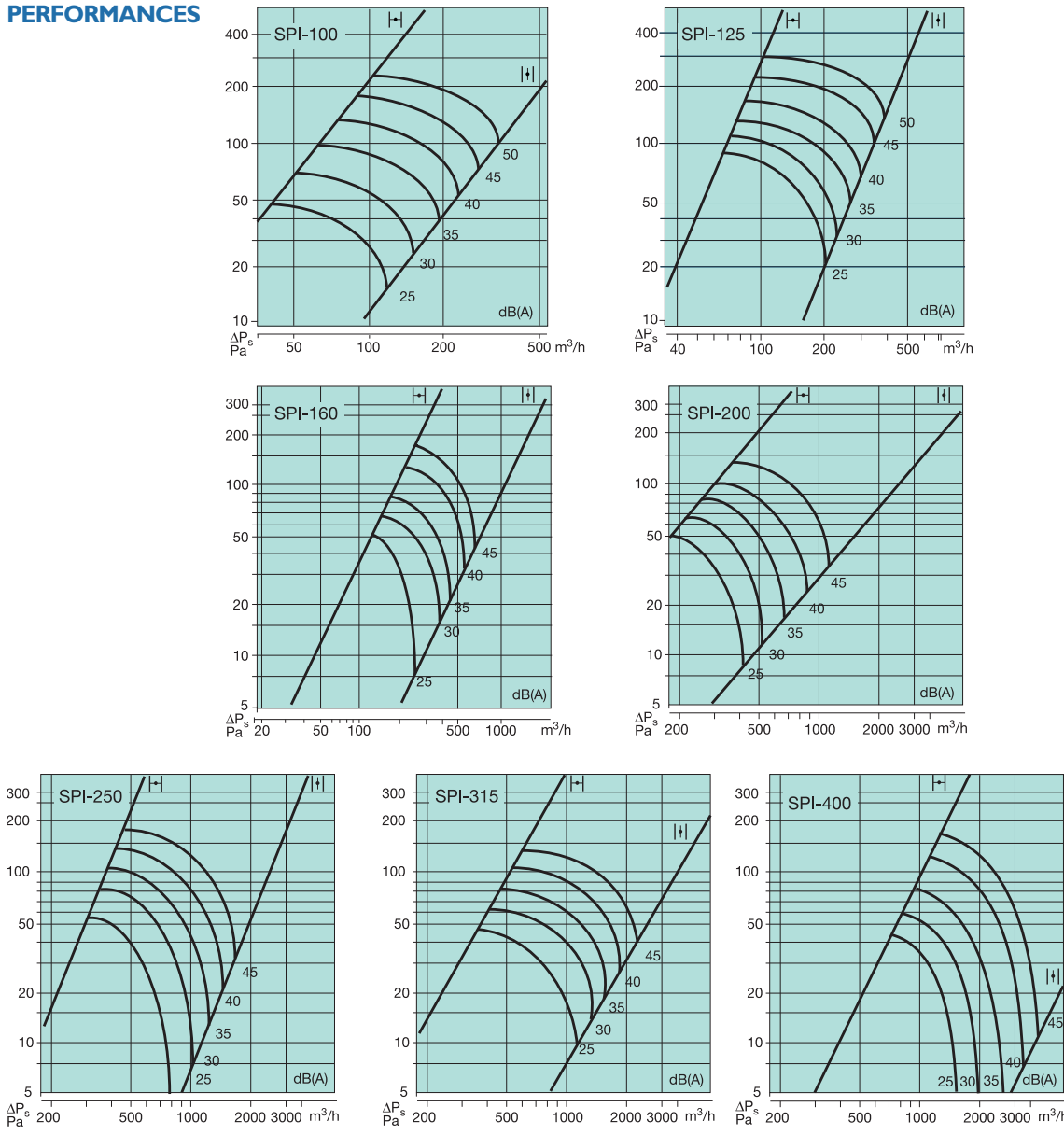

Référence Prix Euros

Registres à iris

SPI-100	●	49,30
SPI-125	●	53,40
SPI-160	●	54,90
SPI-200	●	59,50
SPI-250	●	116,70
SPI-315	●	129,30
SPI-400		269,30
SPI 500		492,10
SPI 630		584,10
SPI 800		1 297,90

Registres à iris étanches

SPM 160	102,30
SPM 200	110,80
SPM 250	152,70
SPM 300	203,00
SPM 315	203,00
SPM 400	369,10

Registres à iris SPI motorisés

SPI-F-100/NM230A	444,40
SPI-F-100/NM24A	444,40
SPI-F-125/NM230A	448,10
SPI-F-125/NM24A	448,10
SPI-F-160/NM230A	450,80
SPI-F-160/NM24A	450,80
SPI-F-200/NM230A	512,80
SPI-F-200/NM24A	512,80
SPI-F-250/SM230A	540,20
SPI-F-250/SM24A	540,20
SPI-F-315/SM230A	552,00
SPI-F-315/SM24A	552,00
SPI-F-SR-100/NM24A	578,50
SPI-F-SR-125/NM24A	581,80
SPI-F-SR-160/NM24A	585,00
SPI-F-SR-200/NM24A	603,50
SPI-F-SR-250/SM24A	695,60
SPI-F-SR-315/SM24A	706,00

Registres à iris SPM étanches motorisés

SPM-F-160/NM230A	490,60
SPM-F-160/NM24A	490,60
SPM-F-200/NM230A	500,40
SPM-F-200/NM24A	500,40
SPM-F-250/SM230A	753,20
SPM-F-250/SM24A	597,40
SPM-F-315/SM230A	648,10
SPM-F-315/SM24A	769,90
SPM-F-SR-160/NM24A	580,00
SPM-F-SR-200/NM24A	590,90
SPM-F-SR-250/SM24A	752,80
SPM-F-SR-315/SM24A	801,80

● En stock